

OPERATOR'S MANUAL

AQ131/275, AQ131/290

AQ151/290, AQ171/290

IMPORTANT INFORMATION

Stop the engine before opening the hatch to the engine compartment. An engine which is running has rotating and moving parts which are dangerous to touch.

Bear in mind the risk of a fire. All engine fuel is inflammable. Alcohol, methanol or ethanol is sometimes added to fuel, especially to unleaded petrol. These additives shorten the life of rubber and plastic components in the fuel system. Inspect regularly.

The cooling system is filled with liquid and it should be drained when there is risk of frost. The fresh water part of the system can

be filled with an anti-freeze mixture or drained. Note that in certain cases a suction action may occur when the sea-water system is being drained. Close all drainage points when the boat is not under constant supervision. Incorrectly performed drainage may cause the boat to become filled with water and sink. When working on the drive in the upper position, lock the drive in position with the special tool available or in some other secure way so that there is no possibility of the drive falling down.

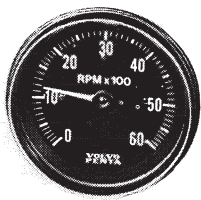

1



2



3



4



5

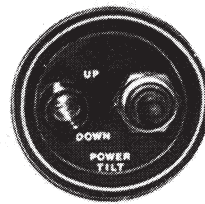

6

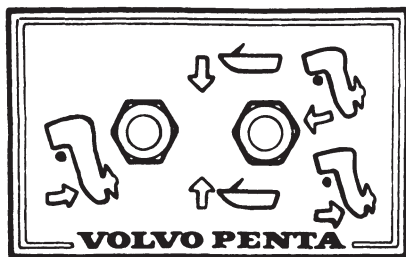

7

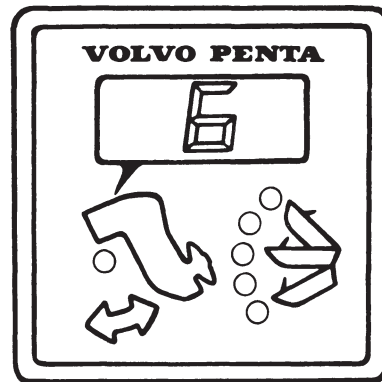

8

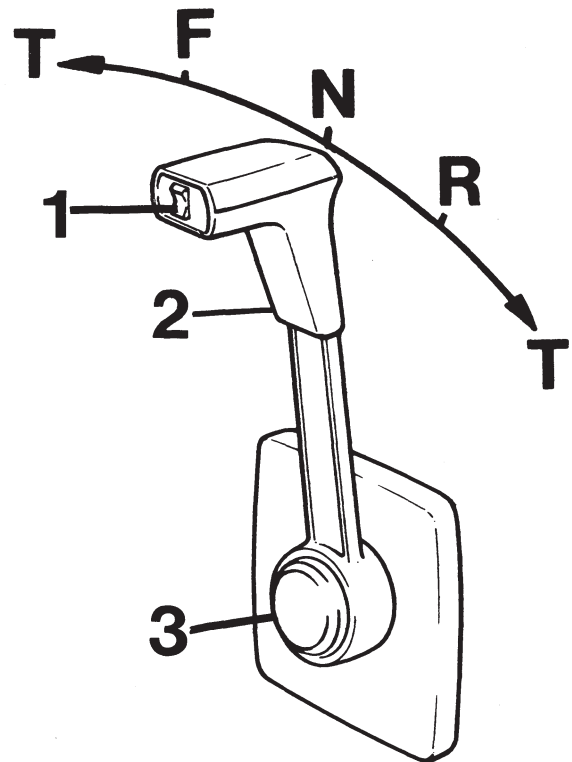
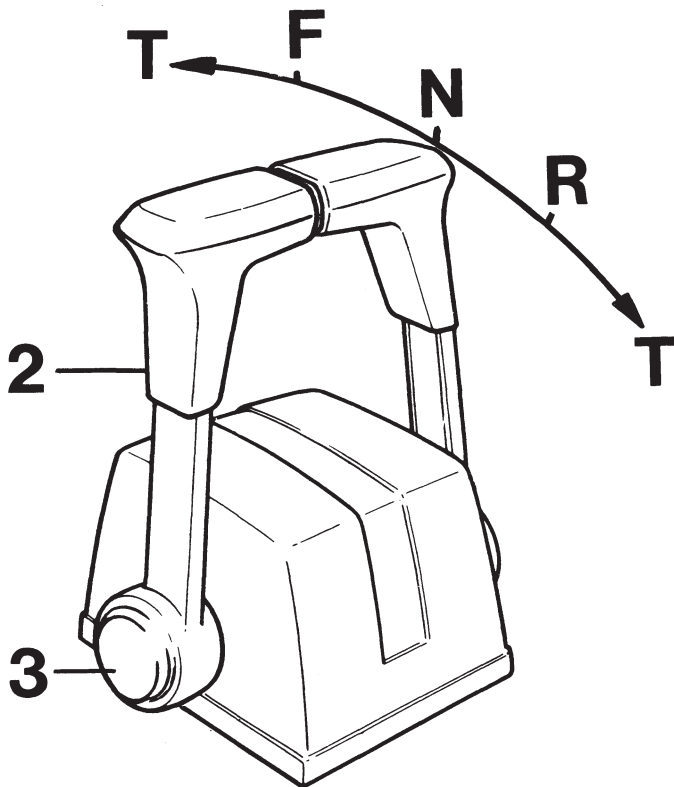

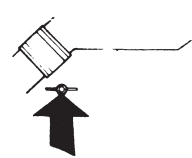
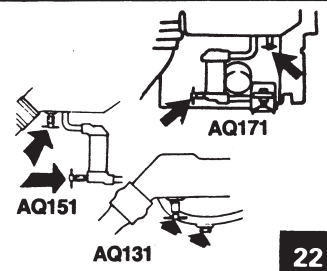
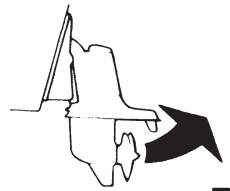
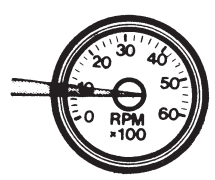
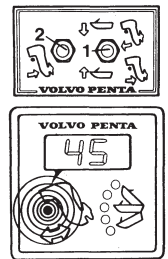
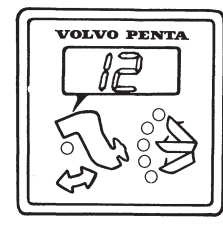
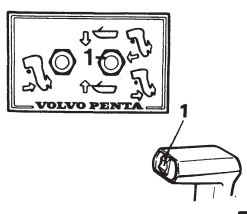
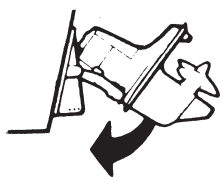
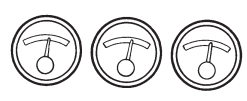
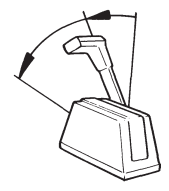
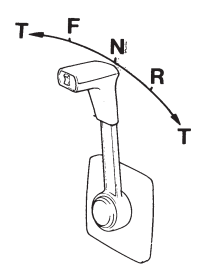
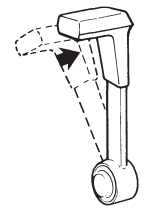
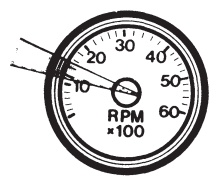
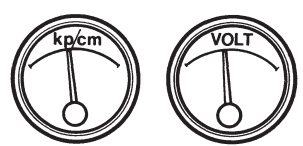
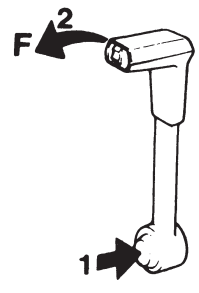
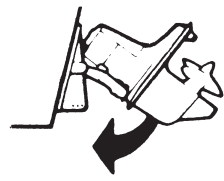
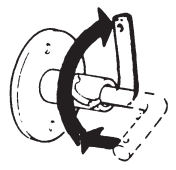
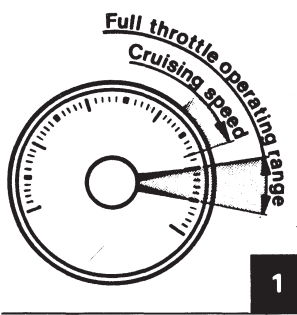

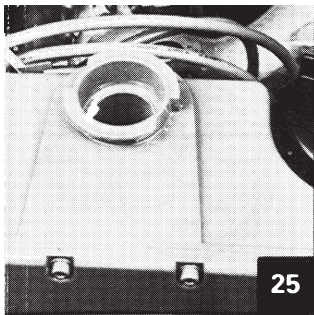

25

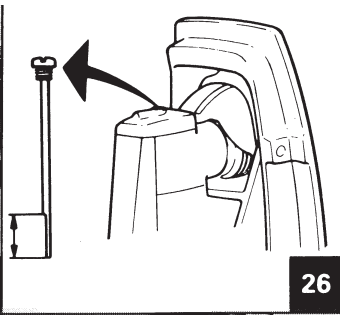

26

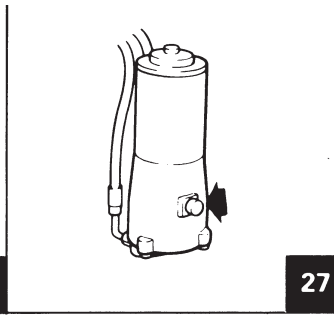

27

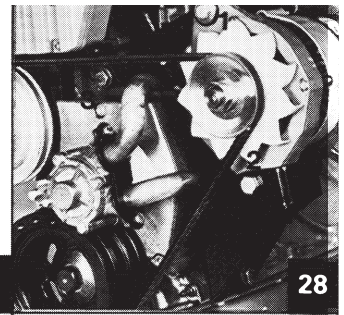

28

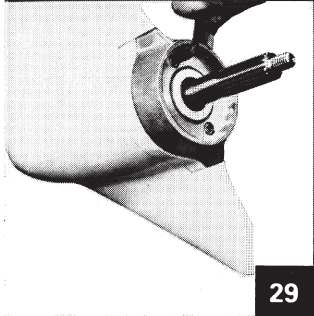

29

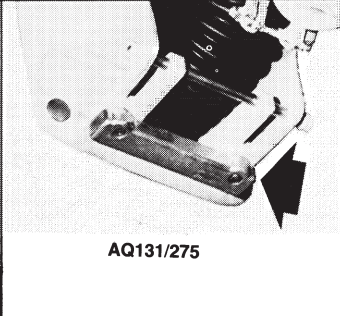

AQ131/275

30

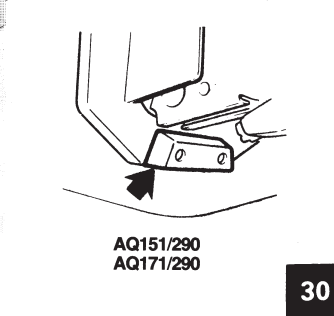

AQ151/290
AQ171/290

30

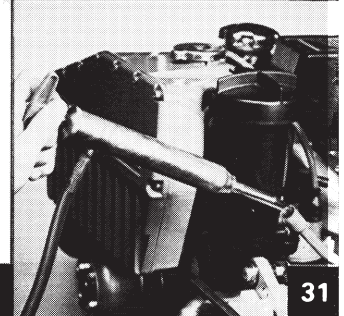

31

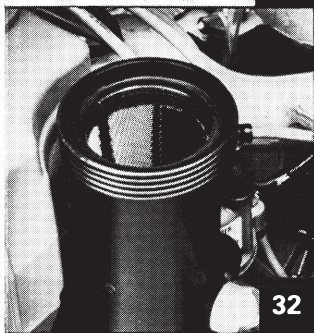

32

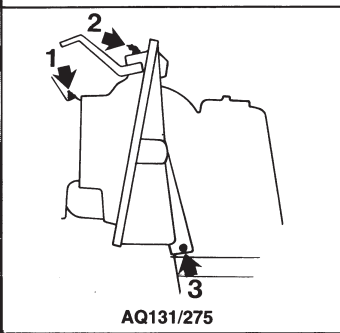

AQ131/275

33

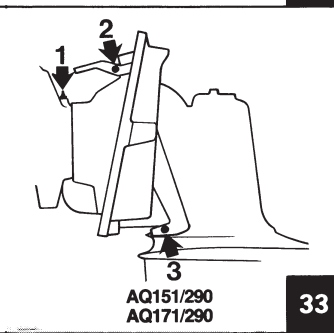

AQ151/290
AQ171/290

33

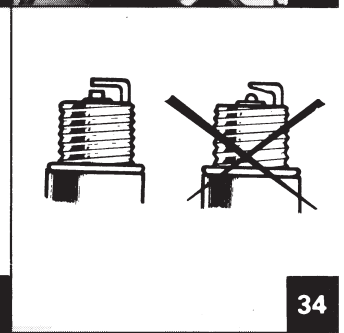

34

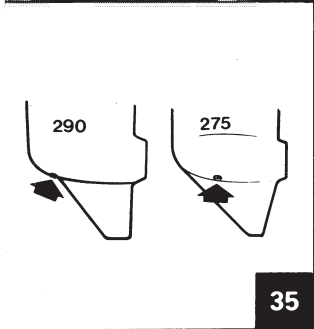

35

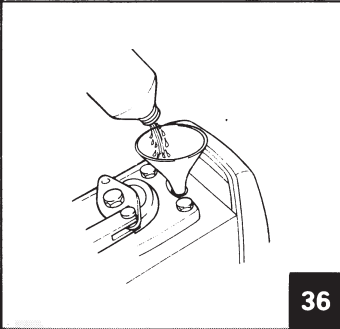

36

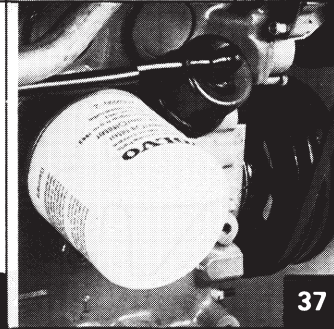

37

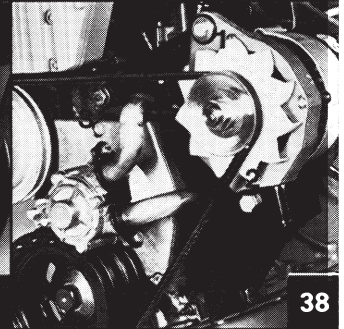

38

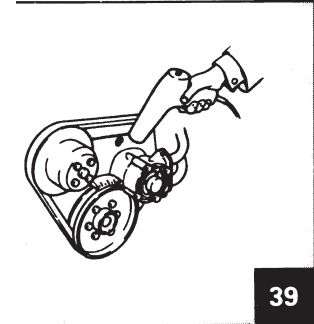

39

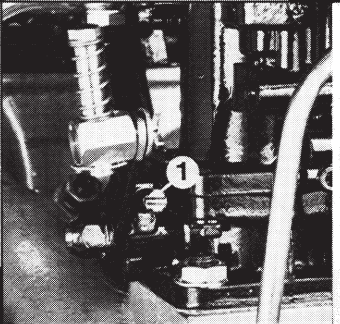

40

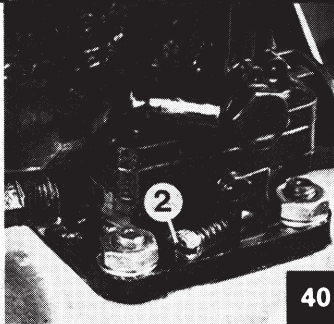

40

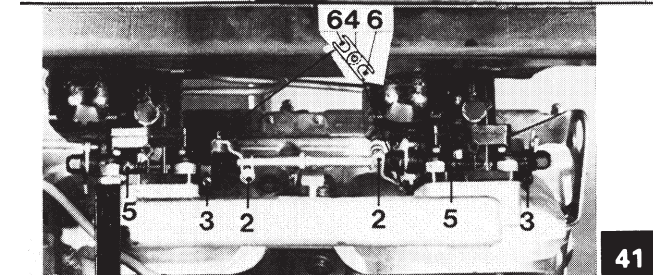

41

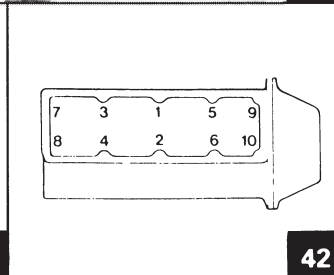

42

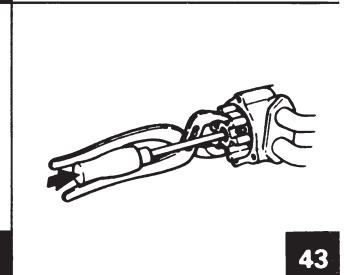

43

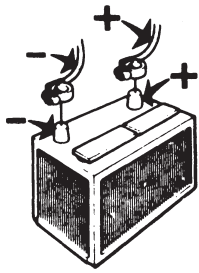

44

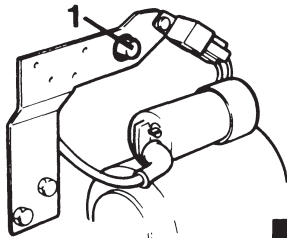

45

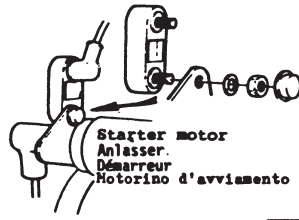

46

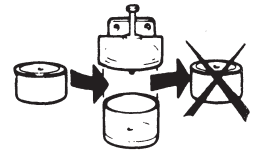

47

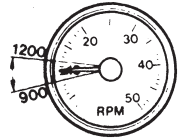

48

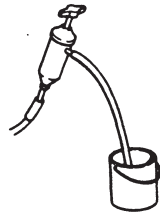

49

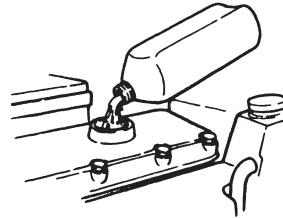

50

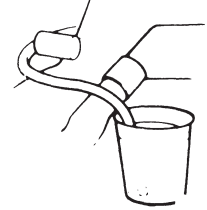

51

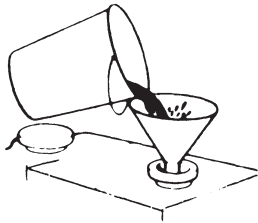

52



53

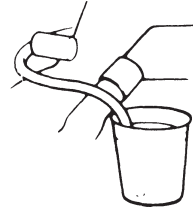

54



55



56

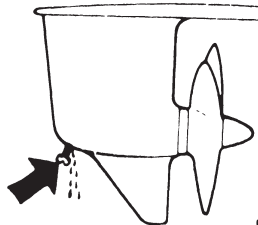

57



58

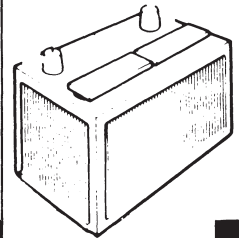

59

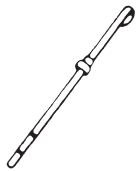

60

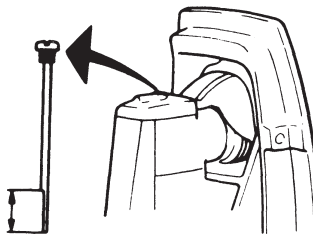

61

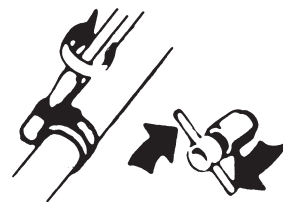

62

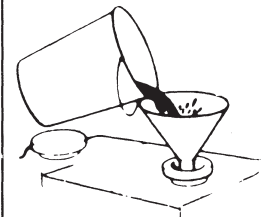

63

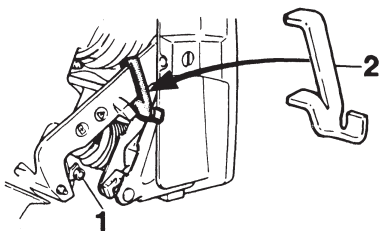

64

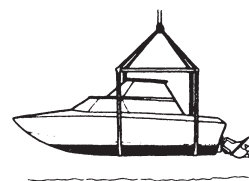
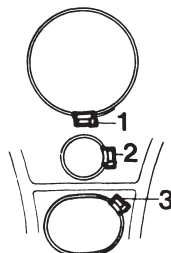

65

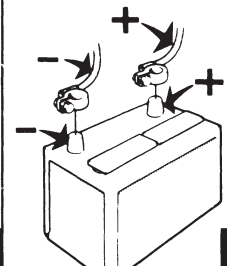

66

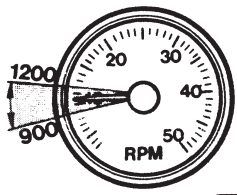

67



68



69



70

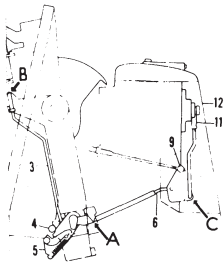

AQ131/275

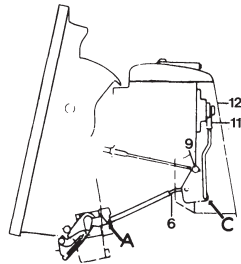

AQ151/290
AQ171/290

71

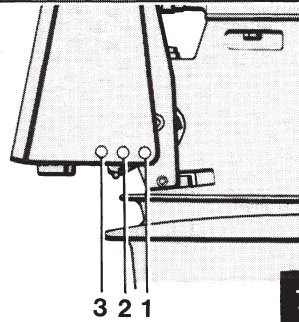

72

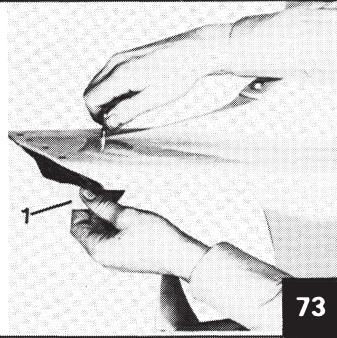
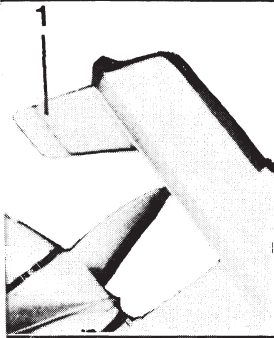

73

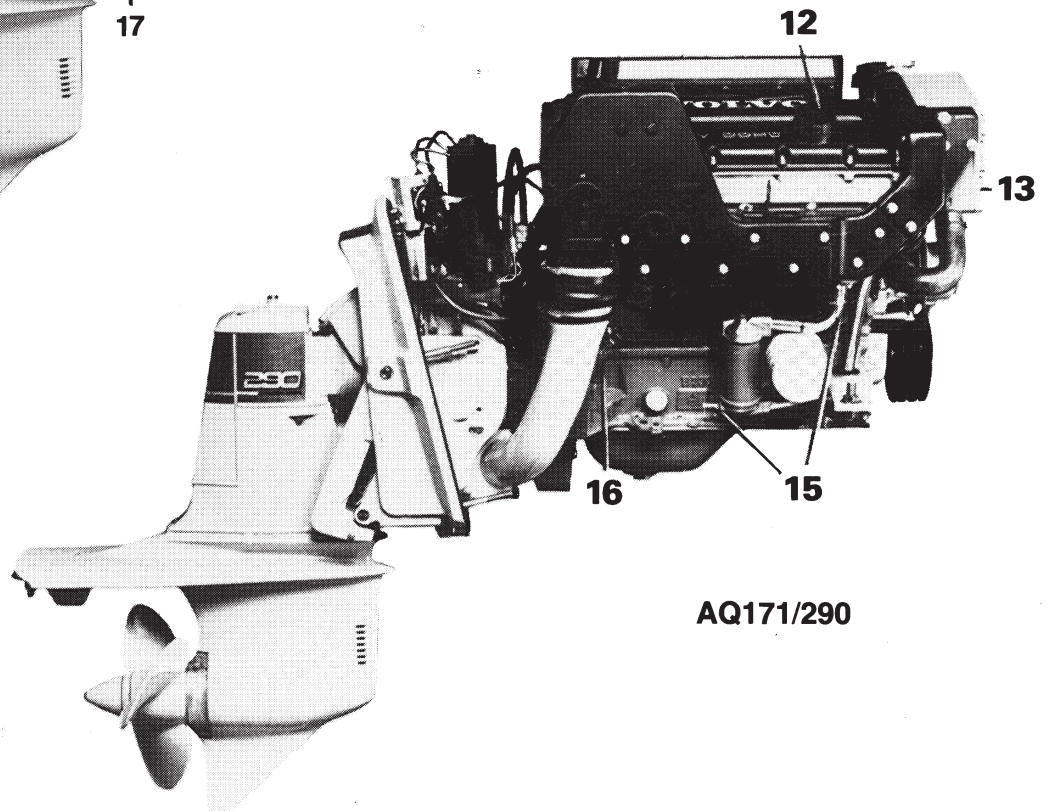
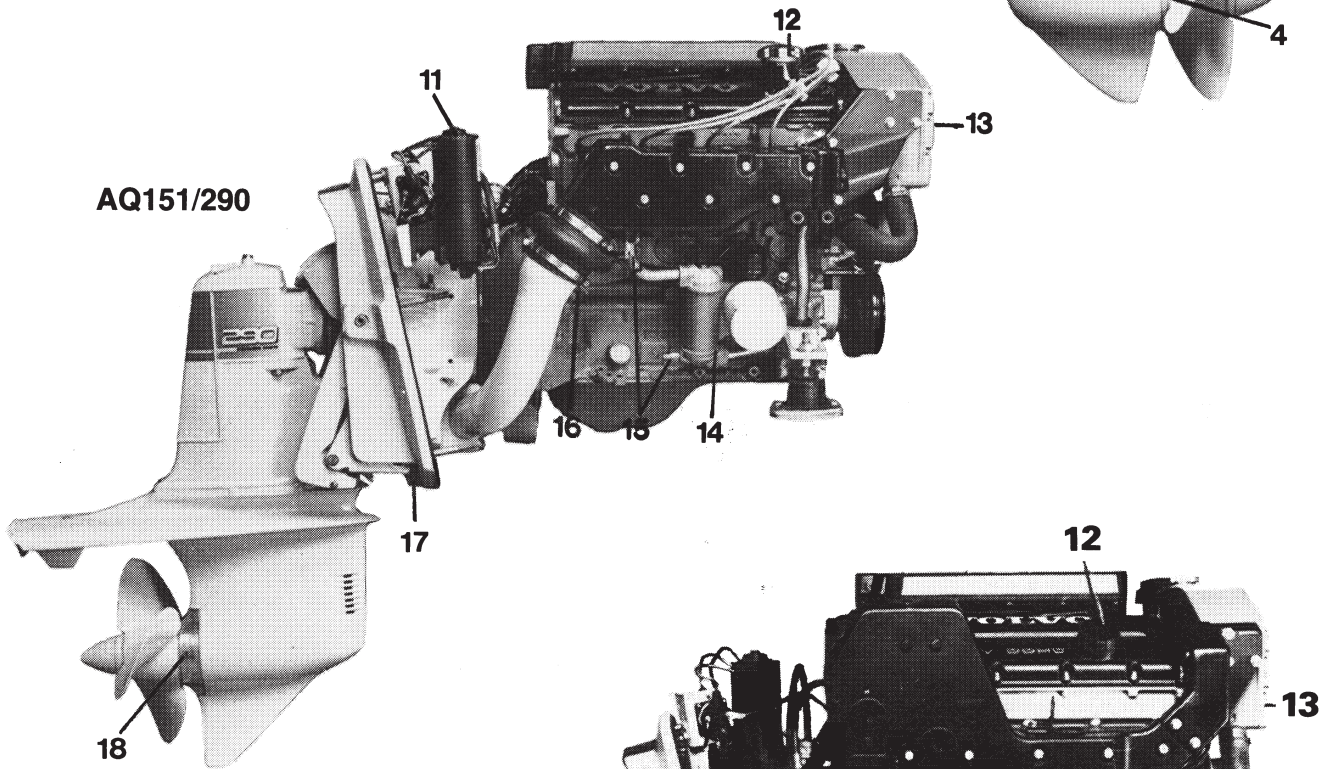
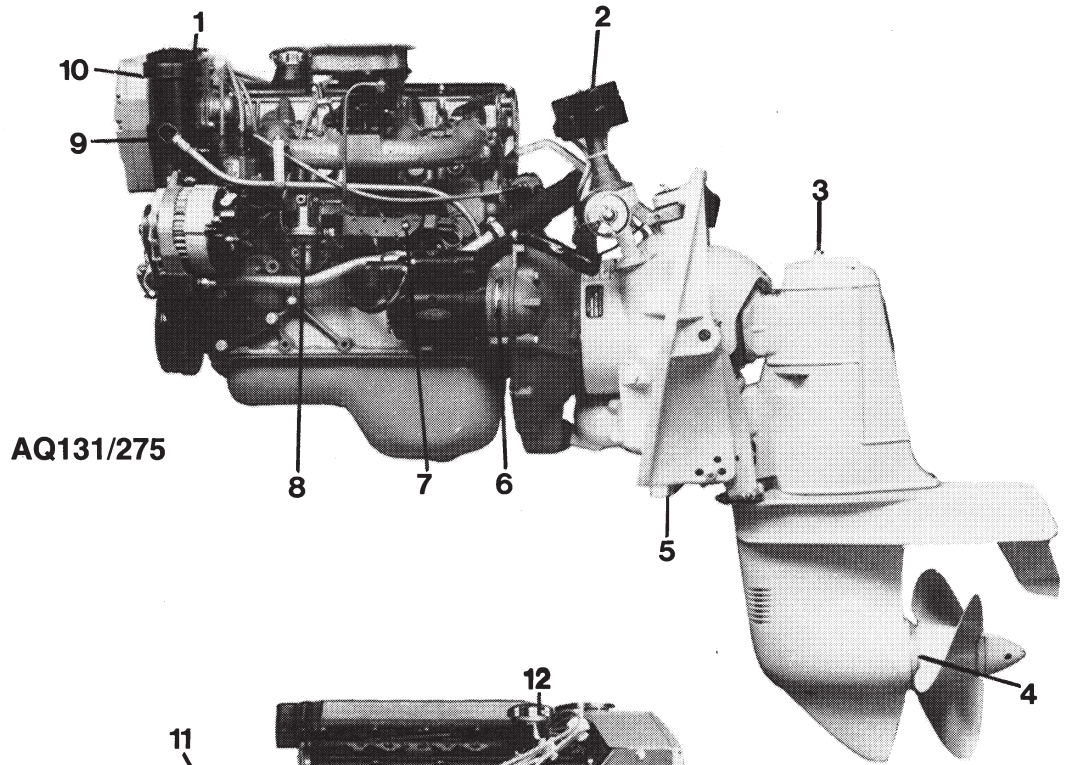

Instrument panel

1. **Tachometer** – graduated 0–6000 rev/min.
2. **Temperature gauge for cooling water.** Green field – normal cooling water temperature
3. **Oil pressure gauge**
4. **Voltmeter**
5. **Key-switch (Starting)**
6. **Drive tilt operating switch** (only AQ131/275)
Position "up" = tilting the sterndrive
Position "down" = lowering the sterndrive
7. **AQ131/290, AQ151/290, AQ171/290**
Operating switch for sterndrive "Up", "Down"
8. **AQ131/290, AQ151/290, AQ171/290**
Instrument indicating the trim angle

Operating controls

1. Operating switch for Power Trim (only AQ151/290)
2. Control lever
3. Disengaging device
Push in the button when the control lever is in neutral and move the lever forwards slightly. Release the button. The lever now operates the throttle only. Pull back the lever when you wish to operate the throttle and the shift-mechanism simultaneously.

N = Neutral

F = Control lever in position for running "Forward"

R = Control lever in position for "reversing"

T = Engine speed

Engine component guide

1. Filling cap checking fresh-water
2. Electromechanical lift device (AQ131/275)
3. Oil dipstick, sterndrive
4. Zinc anode
5. Zinc anode
6. Serial number
7. Reset button, fuse
8. Fuel pump
9. Oil dipstick, engine
10. Sea-water filter
11. Hydraulic pump, Power Trim
12. Oil filler cap, engine
13. Heat exchanger
14. Oil cooler (AQ151, AQ171)
15. Draining, sea-water
16. Draining, fresh-water
17. Zinc anode
18. Zinc anode

CONTENTS

General information	2–3
Running Instructions	3–4
Starting the engine	3
Running instructions	3
Running in shallow waters	4
Reversing	4
Shutdown procedure	4
Checks and Service	4–8
Check daily before starting	4
Check every 14 days	5
Service every 50 hours of operation	5
Service every 100 hours of operation	6
Winter storage and Launching	8–9
Propellers	9
Trimming the Sterndrive	10
Fault Tracing Scheme	11
Technical Data	12
Wiring Diagrams	13–14

Important information

Figures before the text refer to illustrations on pull-out pages of cover.

INTRODUCTION

This instruction book provides helpful information for running and maintaining your Volvo Penta products.

The content applies to particular engine specifications. Each engine is supplied from Volvo Penta in accordance with the published specifications. Examine your engine and other components to be able to find them in this book. Read this book carefully before operating the engine. Do not wait until a problem occurs.

WARRANTY

A service and warranty book which contains the Volvo Penta International Limited Warranty (all markets except USA) should have been provided by the dealer. If you have not received this publication contact the nearest Volvo Penta Dealer for a copy.

Some markets provide special or limited warranties as a supplement or replacement for the Volvo Penta International limited warranty. Contact the Volvo Penta Importer to obtain copies of such special warranties if applicable.

For products operating in the USA special limited warranties and warranty documents apply.

WARRANTY REGISTRATION CARD – DELIVERY CARD

The Warranty Registration Card (US market) Delivery Card (other markets) should be filled in and sent in by the dealer. Warranty service can be refused if no proof or delivery date can be provided.

VOLVO PENTA SERVICE

Volvo Penta has built up an extensive dealer network to support you with service and parts. These dealers have the necessary training, special tools, test equipment and stocks of parts to provide quality service. When requesting service or parts always quote the complete product model and serial number, taken from the product serial number plate.

AB VOLVO PENTA Technical Publications Dept.

INFORMATION NOTICE: All information, illustration and specifications contained in this manual are based on the latest production information available at the time of publication. Volvo Penta reserves the right, without prior notice, to revise prices, materials, standard equipment, specifications, models and to discontinue models. Not all models, standard equipment and accessories are available in all countries. Volvo and Volvo Penta are registered trade marks of AB Volvo.

WARNING

The following special warning notes will alert you to possible bodily injury dangers and to important information on safe operation of equipment. Observe them carefully. "Warning" notes alone do not eliminate the dangers that they signal. Personal close attention to de-

tail plus common sense in operating the equipment, are major accident prevention measures.



WARNING: You are warned that personal injuries, damage to property or malfunction of the engine can result from your not following these instructions.



Please read the Owner's Manual.

GENERAL INFORMATION

Important information concerning the function of your engine:

FUEL

Use gasoline with a minimum of 91 octane (RON). The engine can be run on unleaded fuel. See Technical Data (Ignition System).

The use of unleaded gasoline is becoming more common. Unleaded gasoline with other additives requires special attention. Before the boat is fuelled next time observe the following:

Only use gasoline with sufficiently high octane.

High octane gasoline normally contains lead additives. For gasoline containing low additives of lead or unleaded gasoline an alcohol is often used as an additive to maintain the correct octane level.

If an engine intended for gasoline with lead additives is run on unleaded gasoline it is very likely that increased wear on valves and valve seats will be the result. Alcohol does not have the lubricating effect that lead has.

Alcohol, and in particular methanol, in alcohol mixed gasoline often accelerates the aging of rubber and plastic. This may result in fuel leakage. For safety reasons all rubber or plastic parts included in the fuel system shall be inspected regularly. Examples of included parts are: fuel pump membrane, valves, fuel hoses, gaskets and fuel tanks. Replace immediately suspected parts.

Fuel mixed with alcohol binds more water than pure gasoline which may result in increased corrosion of metal parts in the fuel system. Check regularly.

LUBRICATING OIL

Use only oil with quality SF (SE) according to the API system. Volvo Penta oil for gasoline engines meets these requirements.

RUNNING IN

A new engine must be run in with due care during the first 20 hours of operation. Avoid operating the engine under full load during this period. Higher oil consumption during this running-in period is normal. Check the oil-level in the engine more frequently than normal during this period.

REPLACEMENT PARTS



WARNING: Electrical, ignition and fuel system components on Volvo Penta products are designed and manufactured to comply with industry and regulatory standards to minimize risks of fire or explosion.

Use of non-approved replacement parts, which do not comply with these rules and regulations, could result in a fire or explosion hazard.

When servicing the electrical, ignition and fuel systems insure that parts are properly installed and tightened.

WARRANTY INSPECTION

(Not applicable for the US market)

Is carried out after 20 to 50 hours' running or within 180 days after delivery and by an authorized Volvo Penta dealer.

Maintenance schedules must be followed to maintain warranty coverage.

FULL THROTTLE OPERATING RANGE

1

When fitting a propeller to a specific boat-engine combination it is sometimes hard to select the proper sized propeller for varying load and weather conditions. Therefore Volvo Penta offers a wide range of propeller sizes and types. In some boats there are advantages in selecting a propeller that limits engine rpm, including lower fuel consumption, lower noise, lower vibration and better propeller efficiency. To achieve best comfort and fuel economy it is recommended that the engine is run at full power only during short periods of time. Appropriate maximum cruising speed is 300–500 rpm lower than full throttle rpm.

Full throttle operating range AQ131: 4700–5000 rpm.

Full throttle operating range AQ151: 4800–5500 rpm.

Full throttle operating range AQ171: 5000–5700 rpm.

If the boat has been in the water for some time the boat speed and the maximum engine speed can drop as a result of marine growth on the boat hull and the stern-drive drive. Prevent growth by painting boat hull and stern-drive drive with "copper free" anti fouling paint.

SAFETY EQUIPMENT

Regardless of whether the boat is being used for long cruises or short day trips, it should be equipped with safety equipment as suggested below. This list can, of course, be supplemented according to personal option. Safety equipment should be inspected at regular intervals.

LIFE-JACKETS for all on board, approved type.

FIRE EXTINGUISHER, at least one easily accessible, approved type.

DISTRESS ROCKETS and matches. Packed water-tight.

FIRST AID BOX

TOOLS suitable for the equipment on board.

ON BOARD KIT containing, e.g. an impeller, spare engine parts, etc. (See your dealer for recommended on-board kit for your engine).

ANCHOR with line.

RADAR REFLECTOR

RADIO for listening to, e.g. weather reports.

COMPASS which has been corrected for deviation.

BOOT HOOK and **PADDLE**.

MOORING ROPES, BUMPERS.

FOG-HORN and **WHISTLE**.

SEA ANCHOR

FLASH-LIGHT

EXTRA PROPELLER AND MOUNTING TOOLS.

NOTICE: Most countries have specific equipment and safety requirements that must be complied with to operate boat safely and legally.

PREPARATIONS BEFORE STARTING

Before starting engine make sure that:

There is no **FUEL LEAKAGE**

There is no **WATER LEAKAGE**

There is no **OIL LEAKAGE**

There is no **SMELL OF LP-GAS** in the deep cavities of the boat or elsewhere.

The **OIL LEVELS** are correct

COOLING WATER LEVEL in the expansion tank for the fresh water system is correct. If the expansion tank is empty, cooling system venting must be done after re-filling. See instructions under Checks and Service.

The proper **NAUTICAL CHARTS** are on board for the planned voyage.

There is enough **FUEL** on board for the planned voyage.



WARNING: Make sure when filling your fuel tank that there is no open flame on board. Ventilate the boat and run the engine room fan (if fitted) for 4 minutes before starting the engine. Do not over-fill fuel tank.

If some people are on board for the first time, tell them how to manoeuvre the boat and where to find life-jackets and fire-extinguishers. Also tell them everything else you think necessary from the point of view of safety. Should something unexpected happen during the voyage, very often it is too late to tell those on board how the safety equipment works.

STARTING THE ENGINE

2

Switch on the **main battery switch**.

Start the **engine room blower** (if fitted) and allow it to run for at least four minutes before starting the engine.

3

Lower the drive, if it has been tilted. Make sure there is no obstacle near the propeller. (The warning lamp should be out. AQ131/275.)

4

Disengage the engine throttle control from the shift control as follows.

Push in the button (1) when the lever (2) is in the neutral position and then move the lever slightly forwards. Release the button. The control lever now operates the engine throttle only. **In cold weather:** "Pump" the control lever a few times. N.B. This applies only if the engine is cold.

5

Turn the ignition key one step to the right. Push in and turn the key further to the right to start the engine. Release the key as soon as the engine has started.

6

Check immediately after starting that the **oil pressure gauge** and the **voltmeter** show normal values. If abnormal values are shown, the engine must be stopped immediately and the cause investigated.

7

Run the engine warm at rapid idling speed (1200–1500 rpm). When the needle on the temperature gauge starts approaching the green field, then you may operate the boat.

- 8** Reduce to idle speed and check that the engine runs smoothly.
Pull the throttle lever to neutral.
The shift control is now connected with the engine speed control.

RUNNING INSTRUCTIONS

- 9** The single control lever operates both the speed and the drive shaft.
F = Forwards
R = Reverse
N = Neutral
T = Engine speed

- 10** To obtain good operating economy the engine should not be run at maximum speed for long periods.

Note that the recommended operational speed for longer periods, the "cruising speed" is 300–500 rpm or more lower than maximum full throttle achieved.

- 11** Check that the engine temperature is normal when running (the needle is within the green field) and that the instruments for charging and oil pressure show normal values. If abnormal values are shown the engine must be stopped immediately and the cause investigated.

Running in shallow waters AQ131/275

- 12** If you are uncertain about the depth of the water, reduce the engine speed to idle and then raise the outdrive to tilt position. When the outdrive is in the tilt position, operate the boat at idle speed **only**. Do not attempt to shift into reverse as the reverse lock is disconnected as indicated by the warning light being illuminated.

- 13** Before shifting into reverse the drive must be fully lowered and the tilt warning light off.

 **WARNING:** Failure to follow above instructions will result in extensive damage not covered by Volvo Penta's Limited Warranty.

 **WARNING:** Never shift to reverse when the boat is planing.

- 14** **Running AQ131/290, AQ151/290, AQ171/290**

The outdrive can be hydraulically trimmed ("in" or "out") during boat operation according to the symbols shown on trim adjustment instrument panel. The bow of the boat is lowered when switch no. 1 (on control lever or on instrument panel) is held in the up position. The bow of the boat is raised when switch no. 1 is held down.

 **WARNING:** Do not operate both switch no. 1 on control and switch no. 1 on panel at same time as damage to electronics will occur.

 **WARNING:** Damage caused by shallow water operations (e.e. Physical damage to propeller, sterndrive etc. is not covered by the Volvo Penta limited warranty.

 **WARNING:** When adjusting for maximum trim angle use extreme care.

- 15** The sterndrive is adjustable within specific trim limit angles to obtain the best running position. For the 290 sterndrive the max. trim angle is number 12 as shown on the trim indicator display panel.

- 16** **Running in shallow waters AQ151,171.** If you are uncertain about the depth of the water, it is recommended that speed of the engine be reduced to idle and the sterndrive raised. To allow sterndrive to pass the maximum trim angle, switch no. 2 must be held in while at the same time switch no. 1 must be held in the 'up' position. The drive unit can now be raised to a maximum tilt position of number 44 on trim indicator.

 **WARNING:** Engine must be turned off whenever the drive unit is tilted above number 45 on trim indicator. This area of tilt must only be used when moored in shallow water or transporting boat by trailer.

Manoeuvring astern

- 17** Slow running astern can be carried out with the drive raised to maximum. position of 44.

 **WARNING:** Never shift into reverse when the boat is planing or at engine speed above 800 rpm..

SHUTDOWN PROCEDURE

- 18** After stopping the boat, allow the engine to idle for several minutes at idling speed with the control lever in the neutral position. This avoids subsequent coolant boiling and engine thermal stresses. This is particularly important if the engine has been run at high speed.

- 19** Stop the engine by turning the key back to the switched-off position.

- 20** If there is shallow water at the mooring place and if there is risk that the drive can strike the bottom, it should be fully tilted. **Do not tilt the drive if it is not necessary.**

- 21** Switch off the main battery switch!

 **WARNING:** The main switch must never be switched off until the engine has stopped.

COLD WEATHER PROCEDURE

Check before leaving the boat that there is no water leakage. In cold weather, where there is a risk of freezing, the cooling water must be drained from the engine or the correct mixture of anti-freeze solution added to the cooling water system.

NOTE! In some cases a siphoning effect can arise. If so, remove the suction hose from the transom shield. Do NOT FORGET to reinstall the hose

- 22** **Drain the sea water system** by opening the cock on the exhaust pipe. AQ151, AQ171 the cock on the oil cooler. AQ131 the cock in on the cooling water pipe. Also loosen the cover on the sea-water pump.

 **WARNING:** Close the cocks and tighten the cover before leaving the boat.

- 23** **Drain the fresh-water system** through the cock on the side of the block. Remove the filler cap in expansion tank in order to let the water drain quicker. If the system contains sufficient anti-freeze mixture it does not need to be drained.

CHECK DAILY BEFORE STARTING

OIL LEVEL IN ENGINE

24

Check the oil level daily before starting and make sure that the oil level is within the marked field on the dipstick. Fill with oil when necessary through the oil filler. NOTE! Do not exceed the maximum mark. See "Technical Data" for type of oil.

COOLANT LEVEL IN EXPANSION TANK

25

Check daily before starting for the first time that the coolant level is up to the hole in the filler pipe. If necessary, add an anti-freeze mixture to the correct level.

In case of freezing risks, it is important that the fresh-water system is filled with an anti-freeze mixture. NOTE! Fresh water system should be drained and flushed once per year.



WARNING: Top up using only 50/50 mix of water and anti-freeze.



WARNING: Closed fresh water system is under pressure. If pressure cap is removed when engine is at operating temperature, turn cap to first stop and allow pressure to escape before completely removing cap.

CHECK EVERY 14 DAYS

OIL LEVEL OUTDRIVE

26

Check the oil level with the drive fully down. The oil level should be between the marks on the dipstick, which must **not** be screwed down when measuring the oil level. Make sure that water cannot enter the drive while carrying out the oil-level check. If necessary, top-up with oil through the hole for the dipstick. Use the same type of oil as used in the engine.

NOTE! The O-ring which lies in the groove under the dipstick tightening screw must be in place.

OIL LEVEL IN THE HYDRAULIC PUMP, POWER TRIM (AQ131/290, AQ151/290, AQ171/290)

27

Trim the drive as far in as possible. Remove the screw and check that the pump is filled with oil. Top up if needed, the oil should be level with the filler hole. For the correct oil type check in "Technical Data". When checking the oil level great care should be taken to prevent any dirt or other matter from entering the system. If the system has been emptied; trim the drive "out" and "in" at the same time as oil is filled.

ELECTROLYTE LEVEL IN BATTERY

The level should be 5–10 mm (3/16"–3/8") above the cell plates in the battery. If necessary, top-up with distilled water.



WARNING: Some maintenance free batteries have special inspection instructions which should be followed.

BELT TENSION

28

The belt must be properly tensioned in order to get full alternator output and correct cooling water temperature.



WARNING: Belt too tight may cause short belt life and may damage alternator or water pump bearing. Belt too loose may jump off pulleys or slip causing short belt life. The V-belt must be properly tensioned to get full alternator output and correct cooling water temp.

The belt is properly tensioned when it is possible to depress it 5 mm (3/16") midway between the pulleys.

To tension the belt, slacken the alternator retaining bolts, 1, 2 and 3, tension the belt and the retaining bolts.

A badly worn or cracked belt must be replaced. See under "Checking the drive belts".

CORROSION PROTECTION

29

Replace the zinc ring when it has been worn down by 50 %.



WARNING: Make sure that the contact surface on the drive is clean before installing the new zinc ring, for good metallic contact.

30

Replace the zinc plate under the transom shield when it has been worn down by 50 %.



WARNING: Make sure that the contact surface on the shield is clean before installing the new zinc plate, for good metallic contact.

SERVICE EVERY 50 HOURS OF OPERATION

Changing oil in the engine

31

With a new or reconditioned engine, the oil must be changed for the first time after 20 hours of operation and subsequently after every 50 hours of operation.

Run the engine warm. Suck up the oil through the hole for the dipstick.

Fill oil to the correct level. See under "Technical Data" concerning the type of oil to be used.

NOTE! The oil filter must also be replaced at every other oil change.

Valve Clearance

AQ131, AQ151

The valve clearance must be checked and adjusted by an authorized workshop. See under Valves – Technical Data.

AQ171

This engine has hydraulic valve lifters and therefore valve clearance adjustment is not necessary.

SEA-WATER FILTER

32

When there is risk of clogging the filter, check as necessary or after 25 hours.

To check and clean the sea-water filter, unscrew the cover and lift out the insert. Shake the insert and then rinse it. It can only be installed in one particular way. Check for water leakage after the engine has been started.

 **WARNING! Watch out for seawater entering the boat when working with the seawater filter.**

 **WARNING:** Volvo Penta recommends use of a properly installed sea water strainer to provide engine with an unrestricted flow of filtered cooling water. Regular inspection and cleaning of this strainer is required. Operation in areas where sea weed, sand etc. or other foreign matter might block intake of filter requires more frequent maintenance.

LUBRICATING THE PRIMARY SHAFT AND STEERING SHAFT BEARING

33 Lubricate the primary shaft (1) with about 1 cm³ (0.06 cu.in) water-resistant grease.

Lubricate the upper steering shaft bearing (2) with a grease gun and water-resistant grease until the grease is pressed out at the bearing.

Lubricate the lower steering shaft bearing (3) with a grease gun and water-resistant grease until the grease is pressed out at the bearing.

SPARK PLUGS

34 Check the electrode gap and adjust if necessary. If the spark plugs are damaged or worn, or the edges of the electrodes are rounded, the spark plugs must be replaced. See under "Technical Data".

See under "Technical Data".

AQ171: The spark plugs are accessible when the plastic cover is removed. Use the accompanying special tool.

SERVICE EVERY 100 HOURS OF OPERATION OR AT LEAST ONCE PER SEASON

OIL CHANGE IN DRIVE (EVERY 200 HOURS)

Draining (carried out on land)

35 Remove the oil dipstick. Tilt the drive. Remove the plug under the propeller gear housing and let the oil run out. Refit the plug with its O-ring.

Filling

36 Remove the drive cover and the oil filler plug. Fill up with oil. Concerning quality and capacity see "Technical Data". Refit the plug together with its O-ring. Lower the drive. Check the oil with the dipstick, which must **not** be screwed down when measuring the oil level. Fill up to the correct level through the dipstick hole. If the oil level is too high, the oil must be drained to the correct level. Reinstall the dipstick together with its O-ring.

 **WARNING:** Check that the drain-plug is not leaking.

OIL FILTER

37 The oil filter is to be changed the first time after 20 hours of operation and then after every 100 hours of operation. Remove the old filter. If the oil filter is difficult to remove, there is a special tool which can be used. Alternatively a screwdriver can be driven through the outer section of the filter and then used as a lever.

 **WARNING:** Be careful not to spill oil.

Coat the rubber seal of the new filter with oil. Check the contact surface on the engine and install the filter **by hand** until it touches the contact surface. Turn the filter a further **half turn, not more**.

NOTE! Use only the Volvo Penta genuine oil filter.

Start the engine, run at idling and check immediately that the oil-pressure-gauge shows normal values.

Check the oil-level and check also for leakage around the filter.

CHECKING AND REPLACING THE V-BELT

38 Check the belt thoroughly for wear and cracks. Any indication of such and the belt must be replaced. Loosen the alternator mounting bolts 1, 2 and 3 and slip off the belt. Clean the belt grooves on the pulleys before fitting the new belt. Tension the belts in such a way that it can be depressed 5 mm (3/16") between the pulleys. After a few hours of running recheck the belt tension and adjust if necessary. The most accurate belt tension can be obtained if the belt is adjusted while warm and flexible after engine has been run. Replace belt once per year using only genuine Volvo Penta belt.

CHECKING THE OVERHEAD CAMSHAFT DRIVE BELT

The toothed drive belt which drives the camshaft should be checked and adjusted and when necessary replaced by an authorized workshop.

IGNITION SYSTEM

39 All adjustments to the engine's ignition system should be done by an authorized workshop, which has the proper equipment. Since the ignition system is sensitive, any faulty work on it could have serious consequences.

AQ131, AQ151

Use a stroboscope to check the ignition setting. Concerning the adjustment values, see "Technical Data".

The check should be carried out once per season.

Lubricate the distributor with a few drops of engine oil on the drive shaft lubricating wick under the rotor.

AQ171

The ignition is electronically controlled and is not adjustable.

CARBURETTOR

A properly adjusted carburettor is necessary for smooth running and good fuel economy. For this reason you should let an authorized workshop check the adjustments some time during the season.

ADJUSTING OF THE IDLING (AQ131)

40

1. Unscrew the idle adjustment screw (1) as far back as to allow the idling screw to touch (without pressing) the shoulder of the carburettor housing. Then tighten the idling screw app. 1 1/4 turn.
2. Tighten the mixing screw (2) completely and the unscrew it app. 1 turn.
3. Start the engine and let it run until it has reached normal operating temperature. Check the idling speed, see "Technical Data".

SYNCHRONIZING AND ADJUSTING THE IDLING (AQ151/AQ171)

41

1. Remove the intake air silencer and control cable sviwel from the control lever.
2. Slacken the clamp nut for **one** lever (2) so that the lever can be moved on the intermediate shaft.
3. Unscrew the idle adjustment screws (3) as far back as to allow the idling screw to touch (without pressing) the shoulder of the carburettor housing. Then tighten the idling screws (3) 3/4 turn exactly.
4. Adjust and lock the lever (2) on the intermediate shaft in such a position that **both** levers (2) activate the throttle levers of the carburettors **simultaneously**.
5. Tighten the mixing screw (5), (not too hard!) and then turn it back 1 complete turn.
6. Adjust the position of the sviwel on the control cable so that the pins (6) on the levers (2) will be positioned in **the middle of the gap** on the throttle levers (4) when it is connected to the control lever. Contact the sviwel to the control lever and lock it.
7. Install the intake air silencer and start the engine and let it run until it has reached normal operating temperature.
8. Tighten the mixing screw on one of the carburettors slowly a half turn and then turn it back approx. a half turn from the bottom position. Do this while listening on the engine. Leave the mixing screw in the position where the engine is running at its best. Repeat the performance on the remaining carburettor until you have obtained the best idling speed.
9. Check the idling speed of the engine, see "Technical Data". If necessary adjust the idling screw (3) equally for each carburettor.

CHECK-TIGHTENING THE CYLINDER HEAD BOLTS

42

Let an authorized service workshop check the tightening of the cylinder head bolts with a torque wrench in accordance with the torque diagram. Do this prior to the first start of an overhauled engine and then a second time after 20 hours of operation.

As to the correct torque – see under "Technical Data".

CHECKING THE COOLING SYSTEM

The cooling system functions normally when the needle of the temperature gauge is between 75–90°C (165–194°F). If the temperature is too high this can be caused by the following: blocked sea water intake, blocked sea water filter, defective pump impeller or carrier in the sea water pump, air in the fresh water system, coolant leakage, blocked oil cooler, too low coolant level, slipping or broken drive belt of the circulation pump, blocked heat exchanger, faulty thermostat or instrument and temperature sender. **WARNING: Watch out for water entering the boat** during all work with the cooling system.



WARNING: Do not top with water only. Water by itself reduces the anti-rust protection and anti-freeze qualities of the coolant and has a low boiling point. It can cause damage to the engine if it should freeze. Drain and flush system once per year.

CHECKING AND REPLACING THE IMPELLER

43

The impeller can be damaged, mostly because of lack of water in the pump due to blocked intake or because of improper winter storage. To check remove the cover.

Inspect the impeller. If the impeller is damaged, it must be replaced. Pull out the impeller using a polygrip. Do not damage the housing. The carrier is defective if it is possible to turn the impeller and the shaft.



WARNING: Watch out for water entering the boat.

ELECTRICAL SYSTEM



WARNING: The engine is equipped with an alternator. If the alternator and the regulator are to function without problem, it is important that the following instructions are observed:

1. **The main battery switch must not be switched off until the engine has stopped.**

Never disconnect battery cables or wiring in the charging system when the engine is running. Disconnecting any part of the charging circuit when engine is running will result in failure of the voltage regulator and serious damage to the alternator.

44

2. **Battery terminal polarity must never be mixed up, as it will cause damage or equipment failure.** The battery terminals have a plus and a minus sign respectively. The cable from the minus terminal is connected to the engine block. The cable clamps must be well tightened and then greased.
3. **Do not switch the charging circuits while the engine is running.**

Install a Volvo Penta charging distributor (accessory) to the alternator when more than one battery is connected.

4. In the event the engine has to be started with the help of a spare battery, proceed as follows:

Let the ordinary battery remain connected. Connect the spare battery to the battery with plus to

plus and minus to minus. When the engine has started, remove the spare battery but under no circumstances may the circuit from engine to the ordinary battery be broken.

5. Do not use a rapid charger when the alternator is connected to the battery. Never use a rapid charger as a booster to provide starting voltage.
6. Disconnect both battery cables before doing any work on the alternator or electrical system.
7. Before carrying out any electrical welding on the engine or boat components, disconnect the charging regulator cables at the alternator and insulate the cable ends.
8. Check the belt tension and the cable connections regularly. When disconnecting battery cables always disconnect the negative cable first and reinstall negative cable last.

 **WARNING:** Failure to follow above instructions may cause equipment damage not covered by Volvo Penta Limited Warranty.

Re-set button for circuit breaker (fuse)

45

The engine is equipped with an automatic circuit breaker which breaks the electrical system when overloaded. The automatic fuse has a re-set button (1). Always investigate the reason for the overload.

46

Fuses in the electrical system (Power Trim)

The electrical system for Power Trim has a 55A fuse (one spare supplied with engine) at the starter motor, and a 5A fuse at the control.

CHECKING OF STARTER MOTOR AND ALTERNATOR

Let a Volvo Penta dealer do all checking and repairs of the starter motor and the alternator. All inspection and testing should be carried out in connection with a general inspection of the engine.

BATTERY

 **WARNING:** The battery must never be exposed to naked flames or electric sparks. Do not smoke near battery. Batteries generate hydrogen gas which is flammable and explosive. Battery fluid contains sulfuric acid.

Never let battery acid come in contact with the eyes, the skin or with painted surfaces. Should this happen, flush the area with water immediately. Should the eyes have been in contact with the acid, apply for medical assistance.

Checking the state of charge

The battery will be maintained in top operating condition only by regular routine inspection and maintenance. When not in use, the battery will discharge slowly.

ELECTROLYTE LEVEL

Electrolyte is checked every 14 days or 25 hours of operation. The correct level is approximately 5 to 10 mm (3/16"-3/8") above the battery plates. Add distilled water to bring to proper level, do not overfill. After adding water, battery should be charged for at least 30 minutes by running the engine at high idle. This will ensure proper mixing of distilled water and electrolyte.

SPECIFIC GRAVITY

The electrical capacity of a battery is directly proportional to the specific gravity of the electrolyte and is checked with a hydrometer. A fully charged battery has a specific gravity reading of 1.260 plus .15 or minus .005 at 80°F. Additionally reading from cell to cell must not vary more than technical specification for battery. As specific gravity of electrolyte varies with temperature, the temperature at the time of testing must be known and the hydrometer reading corrected in accordance with the temperature correction chart included with the hydrometer. Specific gravity should be tested at least once per season. (See "Technical Data").

ROUTINE CLEANING

Batteries should be kept clean and dry. Battery connections must be clean and tight. A light film of grease applied to the battery terminals will help to minimize corrosion.

COLD WEATHER!

 **WARNING:** During cold weather, batteries must be charged immediately after adding distilled water. Water floating on top of battery cells will freeze, damaging the battery (see electrolyte level above). Battery capacity is considerably reduced at low temperatures. When stored outside in cold climate it will be necessary to provide a means of keeping batteries warm. If necessary remove batteries and store inside.

FUEL SYSTEM

47

In case an extra fuel filter with water separator has been installed, the water, if any, should be drained through the bottom plug.

Replace at least once per season the filter element in fuel filter.

 **WARNING! When working on the fuel system be careful not to spill fuel. Spilt fuel should be carefully removed and the engine compartment carefully vented prior to starting the engine.**

Pump fuel to engine by turning the engine with the starter.

 **WARNING:** Carbon monoxide is a poisonous colourless and odorless gas which is present in all exhaust gases. If you ever smell exhaust fumes inside the boat make sure all compartments are ventilated and have your engine inspected by your dealer immediately.

WINTER STORAGE AND LAUNCHING

SERVICE IN CONNECTION WITH WINTER STORAGE AND LAUNCHING

INHIBITING

IDLE ENGINE FOR BRIEF PERIODS WITH BOAT IN WATER

In order to prevent damage to the engine caused by corrosion, the engine should be run warm at least every 14 days as long as the boat is in the water. If the boat is not to be used for over a month, long-term inhibiting should be carried out.

INHIBITING WHEN PREPARING FOR WINTER STORAGE

An authorized dealer should test and inspect the engine and equipment before inhibiting the engine for a long period. It is advisable to test the compression to find out the condition of the engine. If anything is not in good condition let the workshop repair it now.

Inhibiting scheme

Carried out with the boat in water

48 Start the engine and allow it to run idle for a few minutes. Stop the engine.

49 Pump out all oil from the engine. Use the oil drainage pump.

50 Change the oil filter. Fill up the engine to the correct level with Volvo Penta engine oil, which also has corrosion protective properties. After this the engine is ready to run on this oil next season. By long-time inhibiting, exceeding a normal winter storage, preservative oil must be used. In this case the oil filter shall not be replaced until launching.

Carried out with boat on land.

51 Remove the sea-water suction line from the transom shield. Connect at 7/8" inner diameter hose to the engine suction line and insert the free end into a container with fresh water. Arrange for filling facilities of the container and then run the engine on idling for a few minutes, thus flushing the engine with fresh water. Be careful not to run the pump impeller dry. Make sure that the area next to the exhaust outlet is not splashed with water. NOTE! Do not let the propeller rotate. Drain all the water from the sea-water system. Close the cocks.

52 The **fresh-water system** can be inhibited against rusting according to 2 Methods below.

Method I. In those cases where the fresh-water system is already filled with an anti-freeze mixture of a preservative type, check the freezing point.

Method II. If the system is filled with fresh water only, drain the water and fill with an anti-freeze mixture of a preservative type (use genuine Volvo ethylene glycol).

Sea-water system

53 Mix a 50 % mixture comprising fresh water and corrosion-proof glycol.

NOTE! Water first, then oil.

Use e.g. Esso Cutwell 40, Shell Donax C or equivalent.

54 Insert the hose into the preservative mixture. Start the engine and let it run idle until the mixture is consumed.



WARNING: The pump must not be allowed to run dry.

55 Drain the engine sea-water system. Impurities can block the cocks, therefore make sure the water drains off.

56 Remove the sea-water pump cover. Check the impeller for damage. Clean the impeller in fresh-water and store it in a plastic bag.

57 Loosen the oil drain-plug at the bottom of the drive to let out a few drops of oil. Check that the oil is clean and not discoloured.

Further inhibiting of the drive is not necessary. Remove the propeller and coat the shaft with a preservative oil.

58 Clean the outside of engine and drive. Touch-in any bare patches in the paintwork with the original type of paint. Spray the components of the electrical system, and all the control components with anti-moisture spray.

59 Remove the battery- For proper maintenance it needs to be charged to prevent it from being damaged.

MEASURES IN CONNECTION WITH LAUNCHING

60 If Volvo Penta oil has been used in the engine, only the level needs to be checked.

If another type of inhibiting oil has been used, both the oil and the filter must be changed. See under "Service every 50 hours of operation".

61 Check the oil level of the drive. If the oil level is too high, it must be lowered by draining. If it is too low, top up through the oil dipstick hole. NOTE! The oil dipstick must not be screwed down, when checking the oil level. Also check the oil level of the hydraulic pump (Power Trim AQ151/290). Top up if necessary.

62 Check to make sure that all the hose clamps are tightened.

Check to make sure that all drain cocks are closed. Check the outside of the engine and drive.

Check to make sure that exhaust hose is not damaged.

63 Check the coolant level in the expansion tank. If the system has been emptied, fill up with fresh water or with a preservative and anti-freezing mixture.

64 Check carefully the bellows for damage and also check the tightening of all hose clamps. NOTE! The bellows and hose clips should be replaced every three years. Have the bellows checked and replaced by an authorized Volvo Penta dealer.



WARNING: Never work on the bellows or the drive's hydraulics without first locking the drive in position in such a way that there is no possibility of it falling down. If the drive falls it can cause severe injuries.

290 DRIVES

You can use Volvo Penta special tool no. 884863-2 to ensure that the drive cannot fall down while you are working on it. Proceed as follows:

Put your hand into the drive from underneath, aft of the shield zinc plate and grip the retaining pawl (1). Press the retaining pawl downwards, at the same time lifting the drive manually until it reaches the upper position. Holding manually until it reaches the upper position. Holding the drive in that position, place the special tool no. 884863-2 (2) on the starboard side of the drive as shown in the diagram. NOTE: Do not overload the tool by standing on the drive while it is in the upper position.

275 DRIVES

To change the bellows or carry out other work on a 275 drive, raise the drive with the electro mechanical lift far enough to be able to dismantle and reassemble the bellows. NOTE: The drive should be secured in position by blocking it with wooden blocks or in some other secure way so that there is no possibility of it falling down.

If the drive has been removed, be careful to install bellows and hose clamps in the correct positions. Check the retaining pawl. Install the propeller. Check-tighten the screw holding the steering helmet to the drive. Tightening torque, see "Technical Data".

- 65** Examine the paintwork on the board drive. Touch up any blemishes with genuine Volvo Penta paint. Then paint the drive with Volvo Penta anti-fouling paint.

 **WARNING:** Anti-fouling paint containing copper must not be used, since this can corrode the drive. Launch the boat once the paint has dried.

- 66** Install the battery or batteries, which must be fully charged. Grease the cable terminals with terminal grease. Connect the battery cables. Important! Do not mix the polarity. Tighten the cable terminals.

- 67** Start the engine. Run the engine warm, if possible with the gear engaged. Check to make sure there is no leakage of fuel, water or exhaust gases in the boat. Furthermore check to make sure that the control functions operate properly.

- 68** When necessary, contact an authorized Volvo Penta service workshop. Let them service your engine and drive according to the instructions given in the servicing scheme.

PROPELLER

Selecting the right propeller

- 69** The right propeller has been selected when the engine maximum speed is obtained with a normal load in the boat.

A left-hand rotating propeller should be selected for single installation. With a left-hand rotating propeller the tendency of the boat to list or veer is reduced.

With a twin installation, the port drive should be adjusted for a left-hand rotating propeller and the starboard drive for a right-hand rotating propeller.

When replacing a propeller, make sure that you get a genuine Volvo Penta propeller of the same size as the old propeller. The size is punched on the propeller hub. Sizes are given in inches, e.g. 15x17, where 15 stands for the diameter and 17 for the pitch.

Removing and installing a propeller

- 70** After having prepared the boat for winter storage, the propeller must be removed and the propeller shaft protected by a preservative oil.

The propeller is locked with a propeller cone and a locking screw in the cone. NOTE! Observe the plastic washer between the cone and the propeller. Pull off the propeller.

NOTE! Inside the propeller there is a spacer sleeve with a deflector ring.

A damaged propeller must be replaced.

Prior to the installation of the propeller the propeller shaft must be greased with a graphite grease or equivalent, in order to prevent the propeller from sticking on the propeller shaft.

When installing the propeller, start with the installation of the spacer sleeve. Then install the propeller and the plastic washer. End by installing the propeller cone. Tighten the locking screw of the propeller cone.

ADJUSTING THE RETAINING PAWL

- 71**
1. Remove the protective cover (12).
 2. Disengage shift cable swivel (9) and the yoke (11).
 3. Release the lock nut for the yoke (11). Adjust the yoke so that, when connected to the lever, it causes the retaining mechanism rod (6) to take up such a position that it reaches the retaining pawl bracket at "A" without pressing against it. Lock the fork (11) with the lock nut.
 4. Adjust the swivel (9) so that it easily enters the hole in the shift yoke. Move the control lever to the "Forward" position. Check to make sure that the corner "C" does not touch the housing. Fit the cover (12).
 5. **AQ131/275**
Push the drive forwards towards the adjusting pin. Check the position of the rod (3). The upper part should be flush with the fork, at "B" so that the lift (1) can disengage the retaining pawl (5) when tilting the drive. Adjust the upper part of the rod after having loosened the lock nuts.

The trim of the boat, AQ131/275

- 72** The transom shield adjusting pin determines the adjustment of the drive trimming angle. Place the adjusting pin in either of the three holes as follows:

Hole 1: When the boat has a tendency to over-planing (the nose dips)

Hole 2: Normal position

Hole 3: When the boat has a tendency to heavy planing (heavy stern)

ADJUSTMENT OF DEVIATION FROM COURSE

- 73** Check any deviation from the course by carefully releasing the wheel when the boat goes in the planing position. If, e.g., the boat veers to port, the trim tab under the cavitation plate on the drive must be released. Then turn the rear edge of the trim tab (1) slightly to port and lock the trim tab in this position. Test run the boat. Adjust the trim tab further if the boat still tends to veer.

Fault Tracing Scheme

Tracing faults when having interruptions in operation

The fault-tracing scheme given below lists only the most usual reasons for faults that cause interruptions in

operation. With the assistance of the instructions given in this Manual, the owner can generally remedy most of the faults listed below. When in doubt, always contact the nearest Volvo Penta service workshop.

Follow the instructions in the Service-Scheme – to ensure optimal reliability in operation

Engine does not start	Engine stops	Engine does not reach correct operating speed at full throttle	Engine runs unevenly or vibrates abnormally	Engine becomes abnormally hot	Reason
●					Main switch off, flat battery, breakage in electric cables or fuse blown.
●	●				Empty fuel tank, closed fuel cock, blocked fuel filter.
●	●		●		Water, air or impurities in fuel.
●	●	●	●		Worn or oily spark plugs.
●					Burnt ignition breaker points, moisture in distributor and on spark plug cables.
	●		●		Idling speed not properly adjusted.
		●			Wrong tachometer.
		●			Boat overloaded.
		●			Marine growth on boat bottom and drive.
		●	●		Damaged propeller.
				●	Blockage in cooling water intake, oil cooler, cooling jackets, damaged impeller or thermostat, too low coolant level in expansion tank.

Technical data

General

Engine designation	AQ131	AQ151	AQ171
Operation	4 stroke fresh-water cooled carburettor engine with overhead camshaft and valves		
Sterndrive, model	275 ¹⁾	290A	290A
Reduction ratio		2,15:1	
Number of cylinders		4	
Output, see sales literature			
Bore, mm (in.)		96 (3.779)	
Stroke, mm (in.)	80 (3.150)		86 (3.385)
Displacement, dm ³ (in ³)	2.3 (141)		2.49 (152)
Compr. pressure kp/cm ² (lbf/in ²) (starter motor speed)		10–12 (142–170)	
Idling speed (rpm) approx.		900	
Direction of rotation looking at crankshaft pulley		Clockwise	
Engine weight, incl. drive approx. kg (lb)	266 (586)	282 (622)	289 (637)

1) AQ131B = 290A

	AQ131	AQ151	AQ171
Valves AQ131, AQ151			
Valve clearance adjustment, hot engine			
Inlet, mm (in.)		0.40–0.45 (0.016–0.018)	
Exhaust, mm (in.)		0.40–0.45 (0.016–0.018)	
Valve clearance adjustment, cold engine			
Inlet, mm (in.)		0.35–0.40 (0.014–0.016)	
Exhaust, mm (in.)		0.35–0.40 (0.014–0.016)	
Valve clearance check, hot engine			
Inlet, mm (in.)		0.30–0.50 (0.012–0.020)	
Exhaust, mm (in.)		0.30–0.50 (0.012–0.020)	
Valve clearance check, cold engine			
Inlet, mm (in.)		0.25–0.45 (0.010–0.018)	
Exhaust, mm (in.)		0.25–0.45 (0.010–0.018)	
Valves AQ171		Hydraulic valve lifters	
Lubricating system			
Oil capacity, engine dm ³ = litres (Imp. qts. = US qts)			
excl. filter	3.5 (3.1/3.7)	4.0 (3.5/4.2)	
incl. filter	4.0 (3.5/4.2)	4.5 (4.0/4.7)	
Oil quality		Multigrade oil Service SF (SE)	
Viscosity		SAE 10W/30 alt. 10W/40 ¹⁾	
Oil pressure hot engine, at full speed, kp/cm ² (lbf/in ²)		2.5–6 (35–85)	
Outboard drive			
Oil quality/Viscosity		Same as in engine	
Oil capacity, dm ³ = litres (Imp. qts./US qts.)	2.2 (1.9/2.3)	2.6 (2.3/2.7)	
Oil capacity between Max. and Min. marks on dipstick, dm ³ = litres (Imp. qts./US qts.), approx.		0.15 (0.13–0.16)	
Oil capacity, hydraulic system drive 290 with Power Trim, dm ³ /litres (Imp. qts./US qts.)		0.52 (0.45/0.55)	
Oil quality		Same as in engine	
Cooling system			
Thermostats, start opening at °C (°F)		82 (180)	
fully open at °C (°F)		92 (197)	
Fresh-water quantity in dm ³ = litres (Imp. qts./US qts.) approx.		7.8 (6.9/8.3)	
Fuel system			
Fuel quality		Regular gasoline min 91 octane (RON)	
Number of carburetors	1	2	
Idle trimming screw, screwed out no. of turns	1 1/4	3/4	
Mixing screw, screwed out no. of turns	1	1	
Ignition system			
Firing order		1-3-4-2	
Ignition timing 850 rpm		6° B.T.D.C	
Stroboscopic setting 4400 rpm		32–36° B.T.D.C	
Distributor, breaker point gap, mm (in) (Not AQ171)		0.40 (0.157)	
Spark plugs	875820-3	W6 DC, part no. 876077-9	
Electrode gap, mm (in)		0.7–0.8 (0.028–0.032)	
Electrical system			
Voltage		12	
Battery, capacity, standard, Ah		60	
Battery electrolyte specific gravity:			
Fully charged battery		1.275–1.285	
When battery is to be re-charged		1.230	
Alternator:			
Output, max.		600 W (50 A)	
Starter motor output, h.p.		1.5	
Tightening torques			
	AQ131, AQ151	AQ171	
Cylinder head bolts			
1st tightening		20 Nm (2 kpm = 15 lb.ft)	
2nd tightening		60 Nm (6 kpm = 43 lb.ft)	
3rd tightening, angle tightening in one sequence	90°	Angle-tighten 120°	
Spark plug		25 Nm (2.5 kpm = 18.5 lb.ft)	
Tension ring, flywheel casing		35 Nm (3.5 kpm = 26 lb.ft)	
Steering helmet screw		35 Nm (3.5 kpm = 26 lb.ft)	

¹⁾ Volvo Penta Multigrade oil.

Wiring diagram AQ131, AQ151

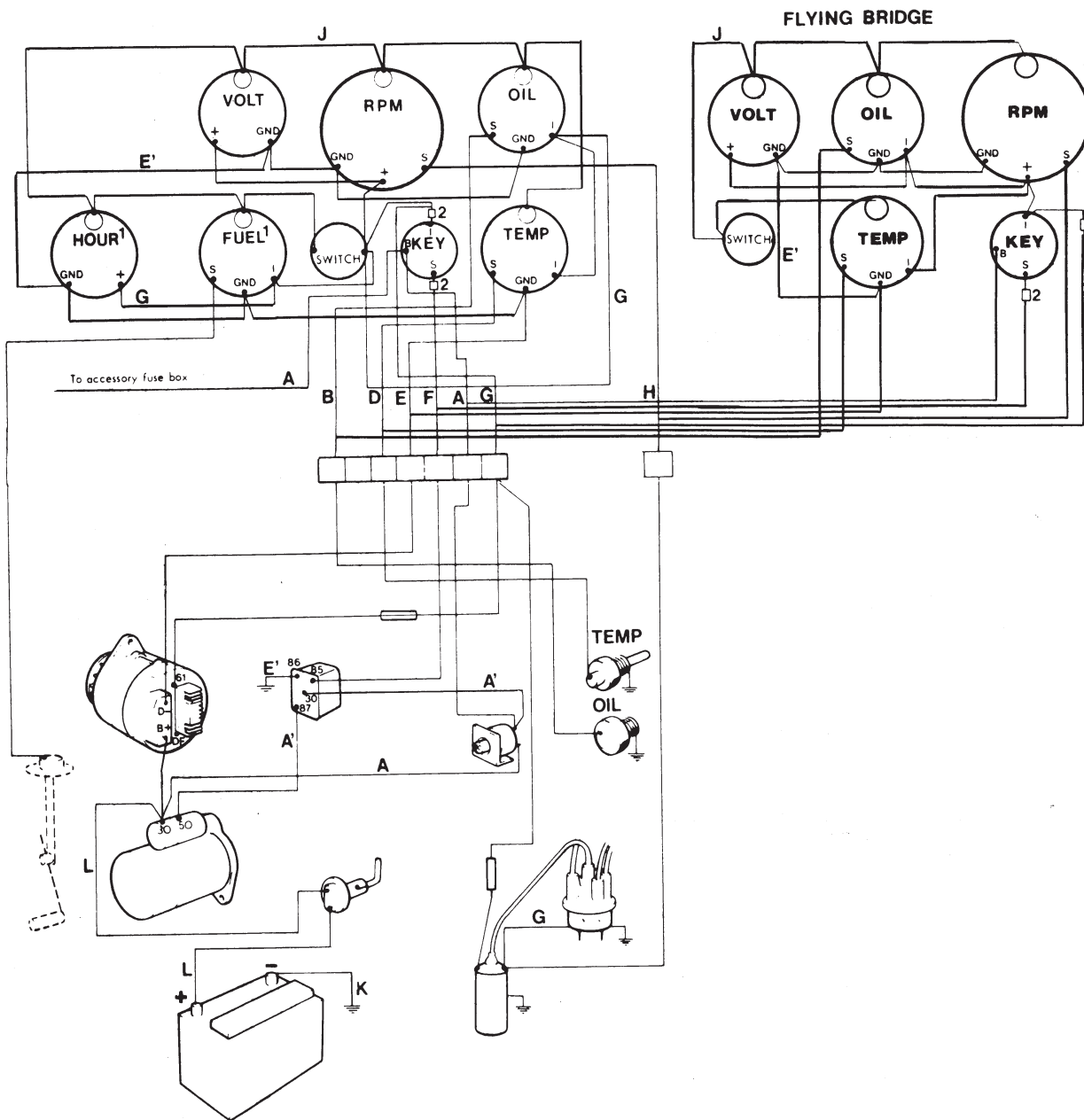

Cable Colour Code

Marking	Colour	mm ²	AWG	F			
A	Red	10	8		Yellow/red stripes	6	10
A	Red	6	10	G	Dark red	1.5	16
B	Light blue	1.5	16	H	Grey	1.5	16
C	Orange	6	10	I	Light yellow	1.5	16
D	Light brown	1.5	16	J	Dark blue	1.5	16
E	Black	6	10	K	Black	35	1
E'	Black	1.5	16	L	Red	35	1

SW, Ignition switch: I=IGN, B=BAT, S=SOL
 Bosch, Ignitions switch: I=15, 75, B=30, S= 50

- 1) Hour meter ofr fuel gauge
- 2) Fuses

Electrical Wiring Diagram – AQ171

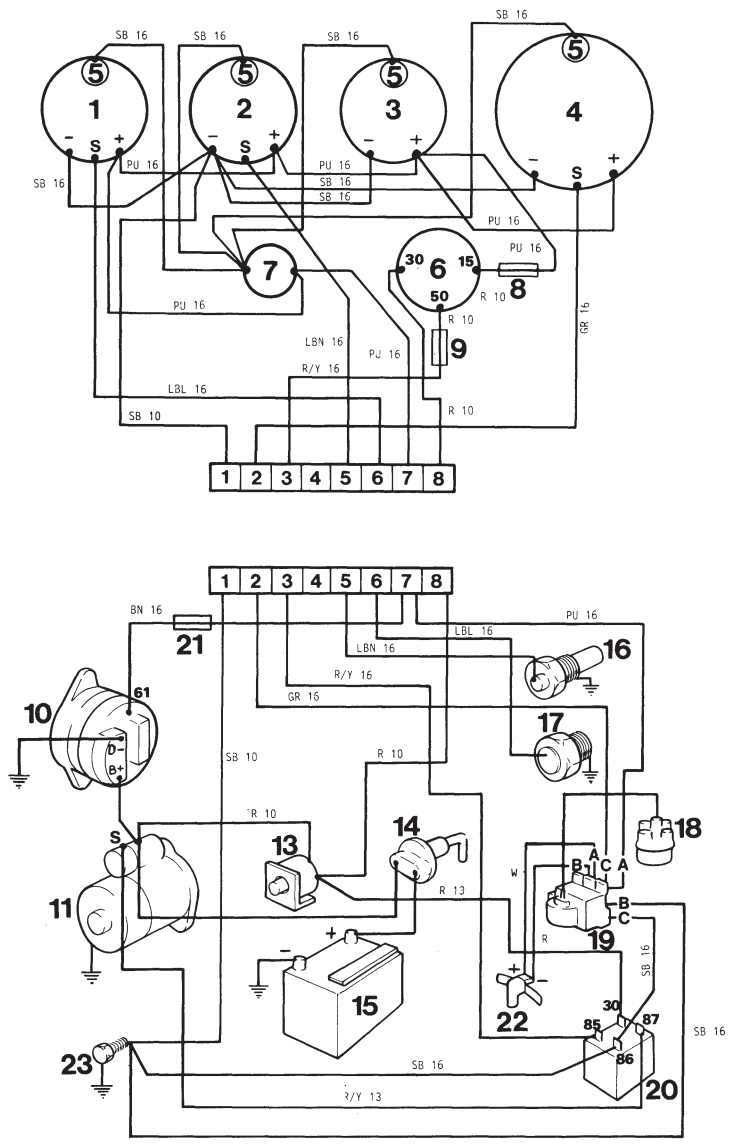

1. Oil pressure gauge
2. Temp gauge
3. Voltmeter
4. Tachometer
5. Instrument lights
6. Key switch
7. Switch, instrument lights
8. Fuse 8 Amp
9. Fuse 8 Amp
10. Alternator
11. Starter motor
12. Terminal block
13. Automatic fuse 40 Amp
14. Main switch (optional)
15. Battery (optional)
16. Temp sender
17. Oil pressure sender
18. Distributor
19. Electronic ignition system
20. Relay
21. Resistor
22. Impuls sender, tachometer
23. Ground (screw)

AWG	mm ²
16	1.5
13	2.5
10	6.0
8	10.0

Cable colour Code

SB	= Black
PU	= Purpur
LBN	= Light braun
R	= Red
GR	= Grey
LBL	= Light blue
R/Y	= Red/Yellow
BN	= Braun
W	= White

Wiring diagram, Power Trim

